





9/16" HY-GEAR®

9/16" Hy-Gear clamps have a wide range of applications, from simple home and auto repair to heavy industrial. The bands have clean punched rectangular perforations that hold strong and connect easily.

9/16" Hy-Gear Ideal Tridon 63-4

BEST





5/16" Hex Head  305 Stainless	UPC Shield  301 Stainless	9/16" Band Width  301 Stainless
--	--	--

9/16" Hy-Gear Ideal Tridon 68-0

BETTER





5/16" Hex Head  410 Stainless	Housing  201 Stainless	9/16" Band Width  201 Stainless
--	---	--

9/16" Hy-Gear Ideal Tridon 50-0

GOOD





5/16" Hex Head  Plated Carbon Steel	Housing  201 Stainless	9/16" Band Width  201 Stainless
--	---	--

9/16" Hy-Gear Ideal Tridon 64-0

SPECIALTY





3/8" Hex Head  410 Stainless	Housing  201 Stainless	9/16" Band Width  201 Stainless
---	---	--

9/16" Heavy Duty Hy-Gear Tridon 60005

SPECIALTY



3/8" Hex Head  305 Stainless	Housing  304 Stainless	9/16" Band Width  304 Stainless
---	---	--



35 lbf-in (4 Nm) for most applications / Minimum destructive torque is 50 lbf-in (5.6 Nm) for plated carbon screws and 60 lbf-in (6.8 Nm) for stainless steel screws.
For Heavy-Duty Hy-Gear, 75 lbf-in (8.5 Nm) suggested installation torque / Minimum destructive torque is 100 lbf-in (11.3 Nm).

FIND YOUR PART NUMBER

Size	Min (in)	Max (in)	Min (mm)	Max (mm)	Ideal Tridon 63-4	Ideal Tridon 68-0	Ideal Tridon 50-0	Ideal Tridon 64-0	Tridon 60005
6	3/8	7/8	10	22	63004-0006	68060	50060	64060	-
8	7/16	1	11	25	63004-0008	68080	50080	64080	-
10	1/2	1-1/16	13	27	63004-0010	68100	50100	64100	-
12	1/2	1-1/4	13	32	63004-0012	68120	50120	64120	-
16	11/16	1-1/2	18	38	63004-0016	68160	50160	64160	-
20	3/4	1-3/4	19	44	63004-0020	68200	50200	64200	-
24	1	2	25	51	63004-0024	68240	50240	64240	60005-0024
28	1-1/4	2-1/4	32	57	63004-0028	68280	50280	64280	60005-0028
32	1-1/2	2-1/2	38	63	63004-0032	68320	50320	64320	60005-0032
36	3/4	2-3/4	19	70	63004-0036	68360	50360	64360	60005-0036
40	1	3	26	76	63004-0040	68400	50400	64400	60005-0040
44	1-1/4	3-1/4	32	83	63004-0044	68440	50440	64440	60005-0044
48	1-1/2	3-1/2	38	89	63004-0048	68480	50480	64480	60005-0048
52	1-3/4	3-3/4	44	95	63004-0052	68520	50520	64520	60005-0052
56	2	4	51	101	63004-0056	68560	50560	64560	60005-0056
60	2-1/4	4-1/4	57	108	63004-0060	68600	50600	64600	60005-0060
64	2-1/2	4-1/2	64	114	63004-0064	68640	50640	64640	60005-0064
72	3	5	76	127	63004-0072	68720	50720	64720	60005-0072
80	3-1/2	5-1/2	89	140	63004-0080	68800	50800	64800	60005-0080
88	4	6	102	152	63004-0088	68880	50880	64880	60005-0088
96	4-1/2	6-1/2	114	165	63004-0096	68960	50960	64960	60005-0096
104	5	7	127	178	63004-0104	68104	50104	64104	-
116	5-3/4	7-3/4	146	197	63004-0116				
128	2-1/2	8-1/2	64	216	63004-0128				
140	2-1/2	9-1/4	64	235	63004-0140				
152	2-1/2	10	64	254	63004-0152				
164	2-1/2	10-3/4	64	273	63004-0164				
176	2-1/2	11-1/2	64	292	63004-0176				
188	2-1/2	12-1/4	64	311	63004-0188				
208	2-1/2	13-1/2	64	343	63004-0208				
224	2-1/2	14-1/2	64	368	63004-0224				
236	2-1/2	15-1/4	64	387	63004-0236				
248	2-1/2	16	64	406	63004-0248				
260	2-1/2	16-3/4	64	425	63004-0260				
272	2-1/2	17-1/2	64	445	63004-0272				
312	2-1/2	20	64	508	63004-0312				
380	2-1/2	24-1/4	64	616	63004-0380				
760	2-1/2	48	64	1219	63004-0760				

Additional sizes available

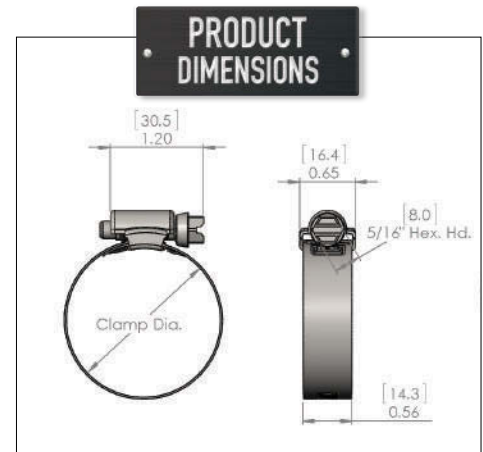

Heavy Duty clamps can be used for difficult sealing applications